

Type 330 All-Welded Flush Mini Diaphragm Seal



TYPE 330

PRODUCT FEATURES

- All welded metal construction, prevents leakage of process media
- Flush design eliminates pockets that could cause clogging or build-up of process media
- Diaphragm area easy to clean up
- Provided with a 1" MNPT process connection
- Compact size to fit space-restricted areas
- No gaskets or bolts
- For use on pressure gauges up to 3½" from 60 to 3000 psi
- Top housing and diaphragm material 316L stainless steel
- ¼ & ½ NPT instrument connection

SPECIFICATIONS

Model Number:	Type 330
Process Connection Size:	1"
Instrument Connection Size:	¼, ½ NPT
Diaphragm Material:	316L SS
Housing Materials:	316L SS
Filling Fluid:	Glycerin, Silicone, Halocarbon, Syltherm

Type 330 All-Welded Flush Mini Diaphragm Seal

Table A – Process Connection

Process Connection	Size	Code
Threaded – male NPT*	1	08

Table B – Type

Description	Code
All-welded flush mini-seal	330

Table C – Diaphragm Materials

Materials	Code
316L stainless steel	S

Table D – Housing Materials

Housing Material	Code
316L SS	S

Table E – Instrument Connection

Instrument Connection	Size	Code
Threaded – female NPT	1/4	02T
Threaded – female NPT	1/2	04T

Table F – Filling Fluid

Fill	Service	Connection to Instrument	Temperature Range °F	Code
Glycerin	Pressure	Direct Only	0/400	CG
Silicone	Pressure/Vacuum	Direct or Flexible Line	-40/600	CK
Halocarbon	Pressure/Vacuum in presence of strong oxidizing agent	Direct or Flexible Line	-70/300	CF
Syltherm	Pressure	Direct or Flexible Line	-40/750	HA

Monel is a registered trademark of Huntington Alloys, Inc.
Hastelloy is a registered trademark of Cabot Corp.
Halocarbon is a registered trademark of Halocarbon Products
GYLON 3510 is a registered trademark of Garlock Inc.

HOW TO ORDER:

1. From Table A...select PROCESS CONNECTION (e.g., 1/4" process code 25)
2. From Table B...select TYPE (330)
3. From Table C...select DIAPHRAGM MATERIAL. (e.g., 316L stainless steel–code S)
4. From Table D...select HOUSING MATERIAL. (e.g., stainless steel–code S)
5. From Table E...select INSTRUMENT CONNECTION size. (e.g., 1/4 NPT–code 02T)
6. From Table F... select FILLING FLUID, if diaphragm seal will be attached to instrument. (e.g., Glycerin–code CG)

Coded order: 25-330SS-02T-CG

Dimensions

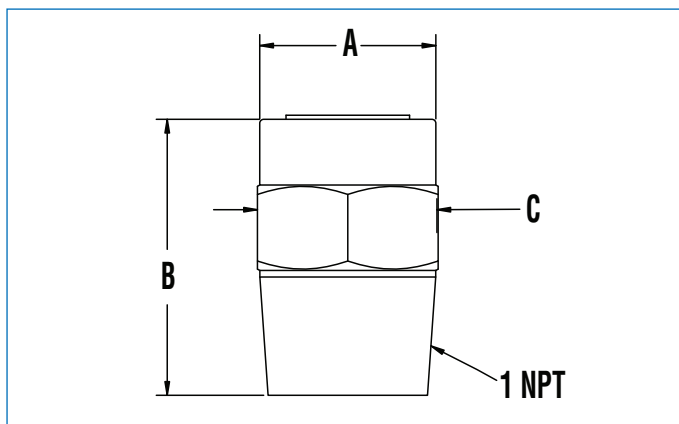

Type 330 All-Welded Flush Mini-Seal 1/4, 1/2 NPT

Size	in	A mm	in	B mm	in	C mm
1 1/2"	1 11/32	(34)	2 5/8	(54)	1 3/8	(35)